

iTrack TEC Series

TL15-30W

Reflector

Technical Parameters:

Name	Parameters
Light source:	COB
Input Voltage:	AC220~240V 50/60Hz
LED Current:	700mA, 35-37V
Rated life:	>50,000 hours
Operating temperature:	-20°C~40°C
Storage temperature:	-30°C~60°C
Certificate:	TUV/CE/RoHS
Weight:	1.75KG

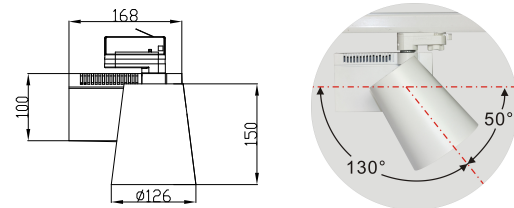

Ordering Information:

○ White ● Black

Power	CRI	Beam Angle	Luminous	CCT	Housing	Part Number
30W	>80	▲ 12°	2830 lm	3000K	○	TL154-30W-830-W-12
					●	TL154-30W-830-B-12
		3030 lm	4000K	○	TL154-30W-840-W-12	
				●	TL154-30W-840-B-12	
		▲ 20°	2860 lm	3000K	○	TL154-30W-830-W-20
					●	TL154-30W-830-B-20
	3050 lm	4000K	○	TL154-30W-840-W-20		
			●	TL154-30W-840-B-20		
	▲ 45°	2740 lm	3000K	○	TL154-30W-830-W-45	
				●	TL154-30W-830-B-45	
	2920 lm	4000K	○	TL154-30W-840-W-45		
			●	TL154-30W-840-B-45		
>90	▲ 12°		2590 lm	3000K	○	TL154-30W-930-W-12
					●	TL154-30W-930-B-12
		2690 lm	4000K	○	TL154-30W-940-W-12	
				●	TL154-30W-940-B-12	
		▲ 20°	2600 lm	3000K	○	TL154-30W-930-W-20
					●	TL154-30W-930-B-20
	2720 lm	4000K	☐	TL154-30W-940-W-20		
			●	TL154-30W-940-B-20		
	▲ 45°	2480 lm	3000K	○	TL154-30W-930-W-45	
				●	TL154-30W-930-B-45	
	2600 lm	4000K	☐	TL154-30W-940-W-45		
			●	TL154-30W-940-B-45		

Technical Data test pattern

CRI80 12°

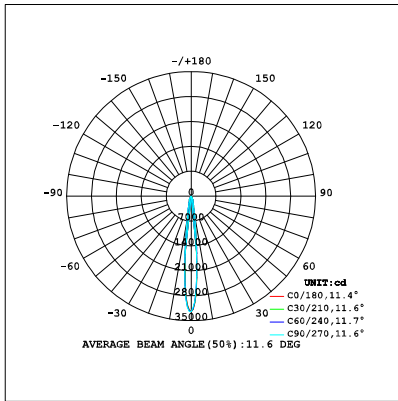

3000K

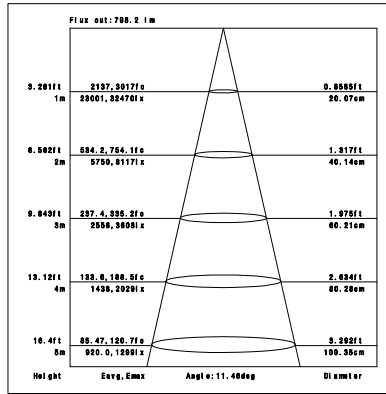

4000K

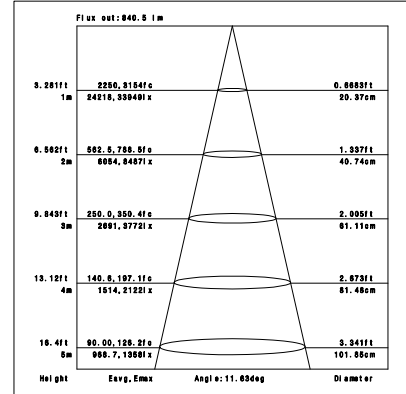

CRI80 20°

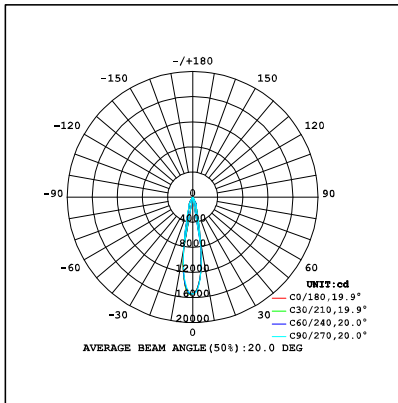

3000K

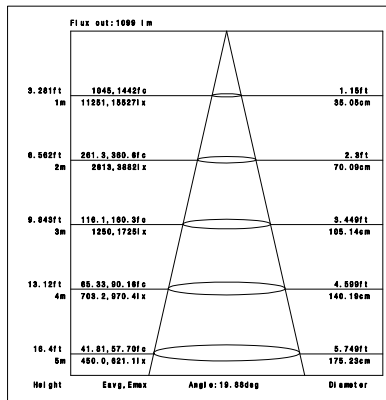

4000K

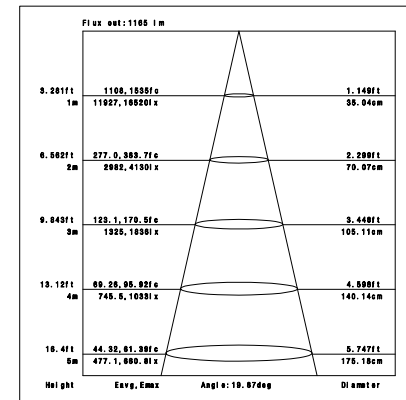

CRI80 45°

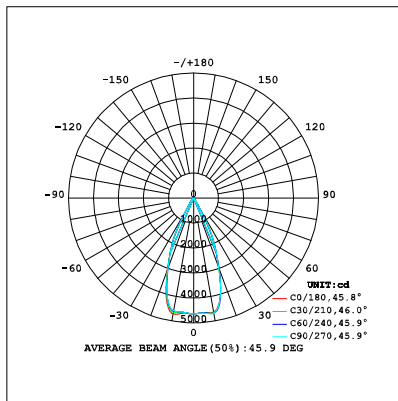

3000K

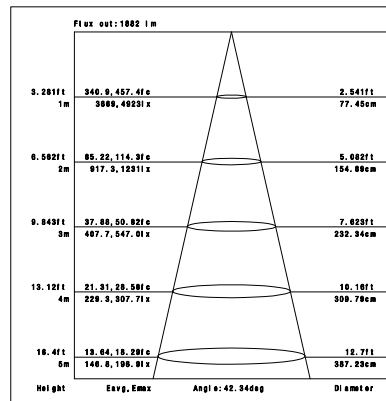

4000K

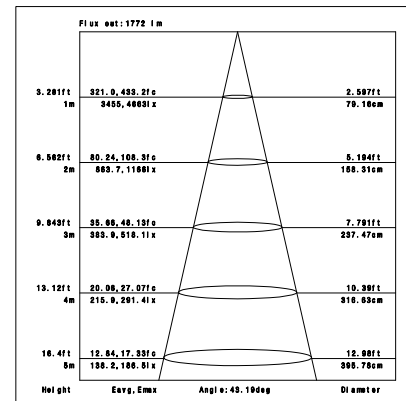

CRI90 12°

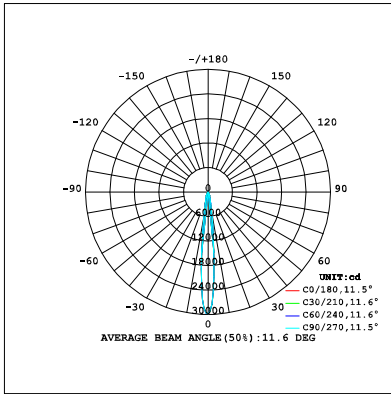

3000K

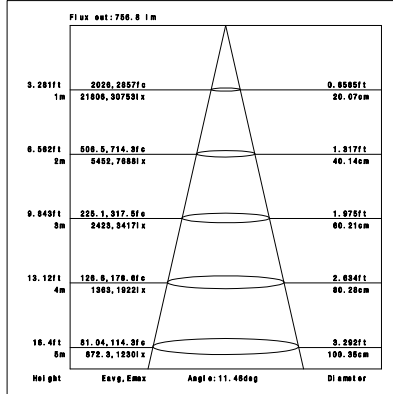

4000K

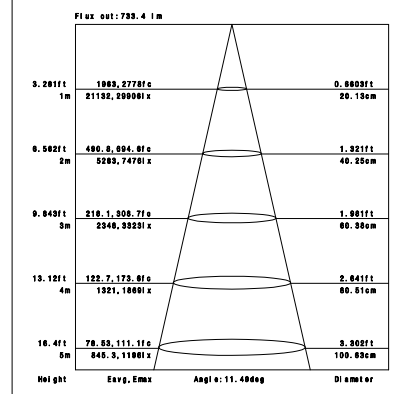

CRI90 20°

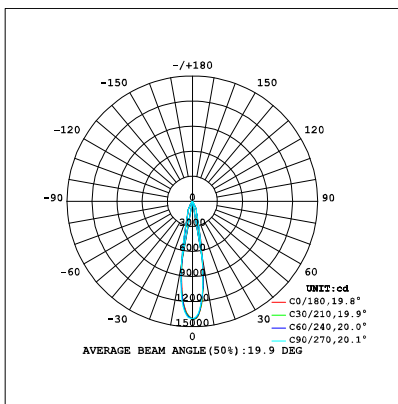

3000K

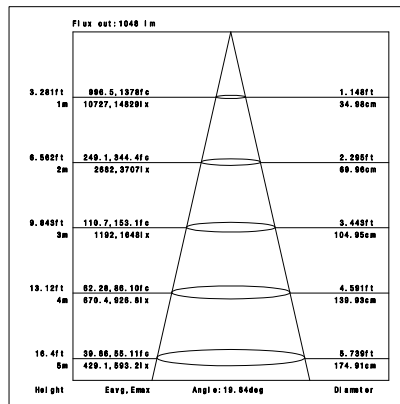

4000K

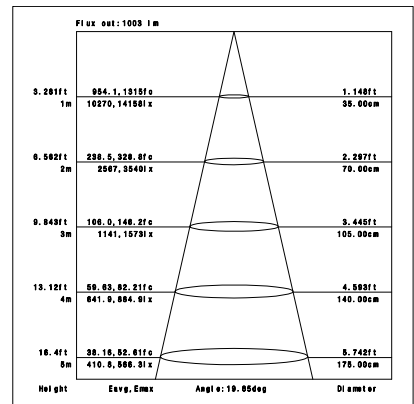

CRI90 45°

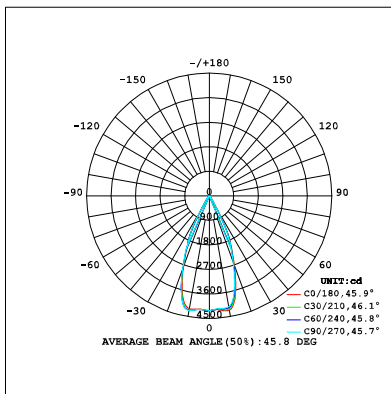

3000K

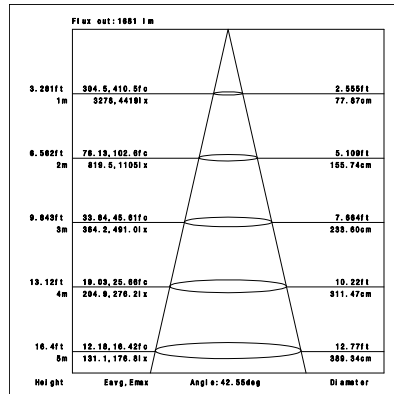

4000K

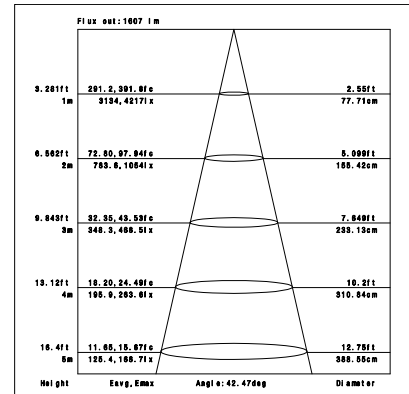

Packaging:

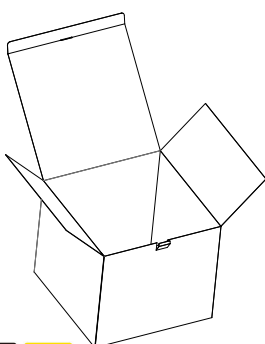

Box
 L245*W245*H220mm
 1pc/box
 GW: 1.95kg/box

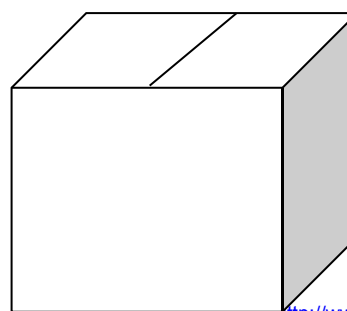

Outer carton
 L520xW520xH460mm
 8 pcs/CTN
 GW: 17kg/carton

Installation instruction

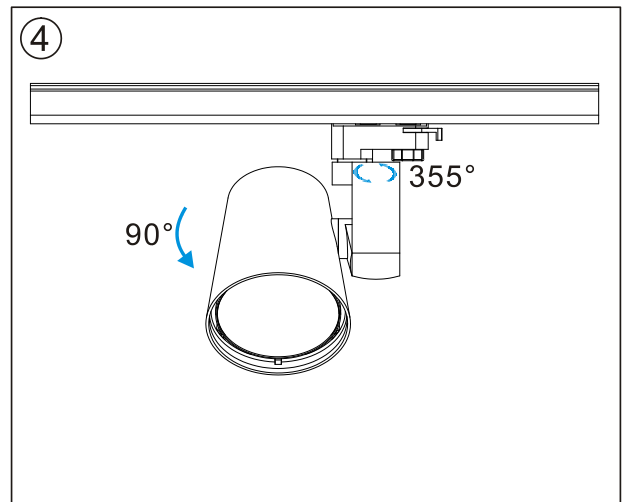
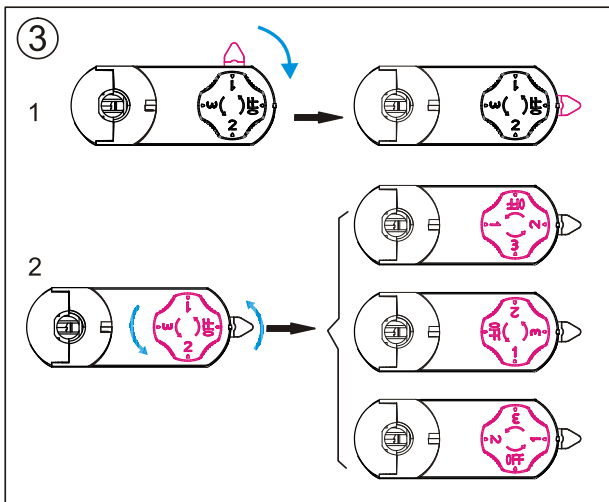
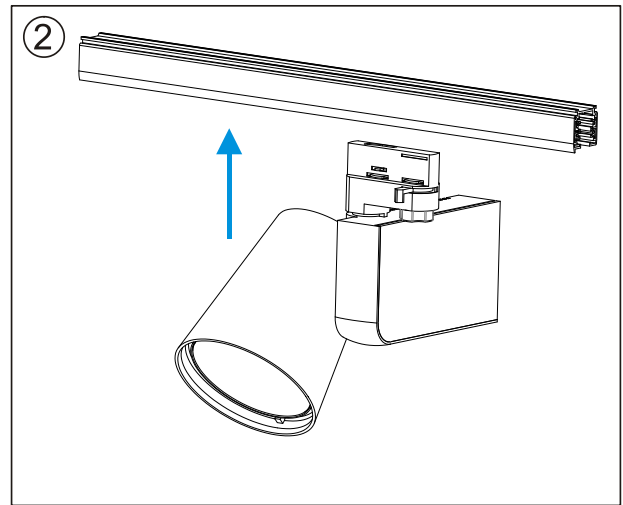
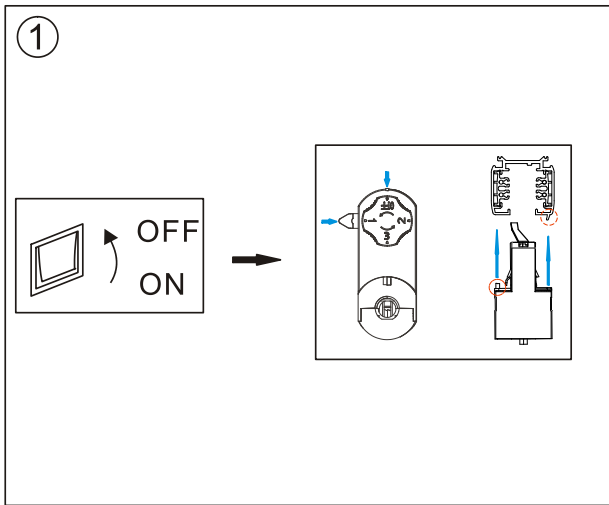

Cautions

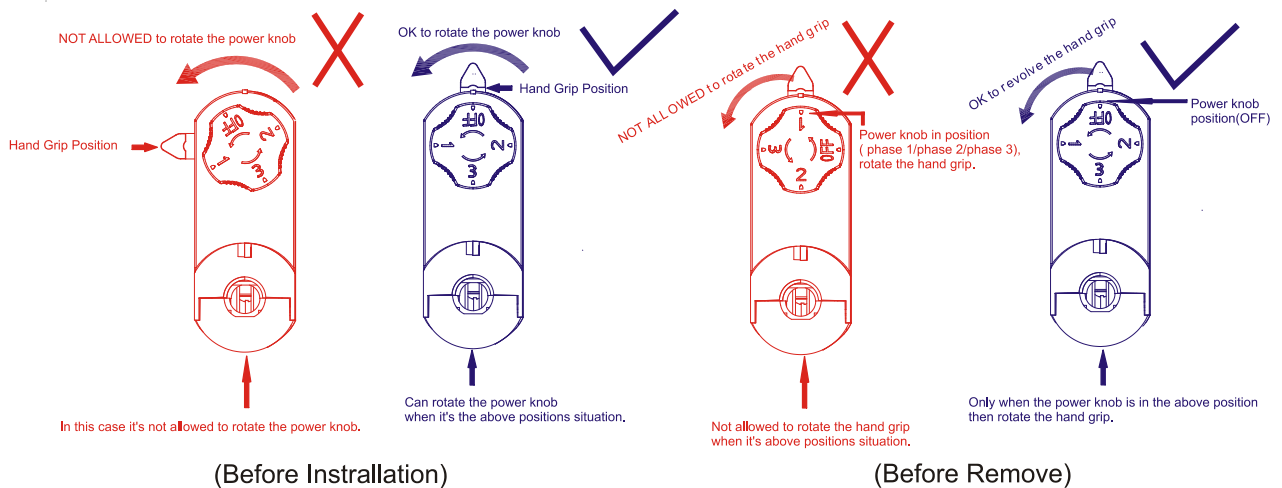

Product naming system

TL (X) XX X (H) - XW - X XX - X - XX

